



MEE-SERIES

MECHANICAL,
ELECTRICAL

CONTENTS

- 3** Specialist fixture solutions
- 3** Fixture assembly
- 4** Electromechanical fixture
- 5** Available housing types
- 5** Interface
- 6** Electromechanical exchangeable cassette system
- 7** Available housing types
- 8** Interface
- 8** Fixture configurator
- 9** Spare parts for the MEE-Series

Imprint

Publisher:

ATX Hardware GmbH West

Am Kornfeld 8

86932 Pürgen

Germany

Phone +49 8196 9304-0

Telefax + 49 8196 9304-19

E-Mail: projekte@atx-hardware.de

Website: www.atx-hardware.de

SPECIALIST FIXTURE SOLUTIONS

ATX is Europe's market leader in the manufacture of test fixtures for electronic test procedures.

Why you too should choose an ATX fixture - it's simple:

TECHNICAL KNOW-HOW

Our sales team is technically well versed - our consultants are selected from the design team or other technical departments.

PROJECT KNOW-HOW

We work together with you towards a common goal: to find and implement the optimal solution for your individual testing requirements.

KNOWLEDGE BASE

Our employees bring well over 1,000 man-years of fixture building experience to the team.

SINCE 1997

FIXTURE ASSEMBLY

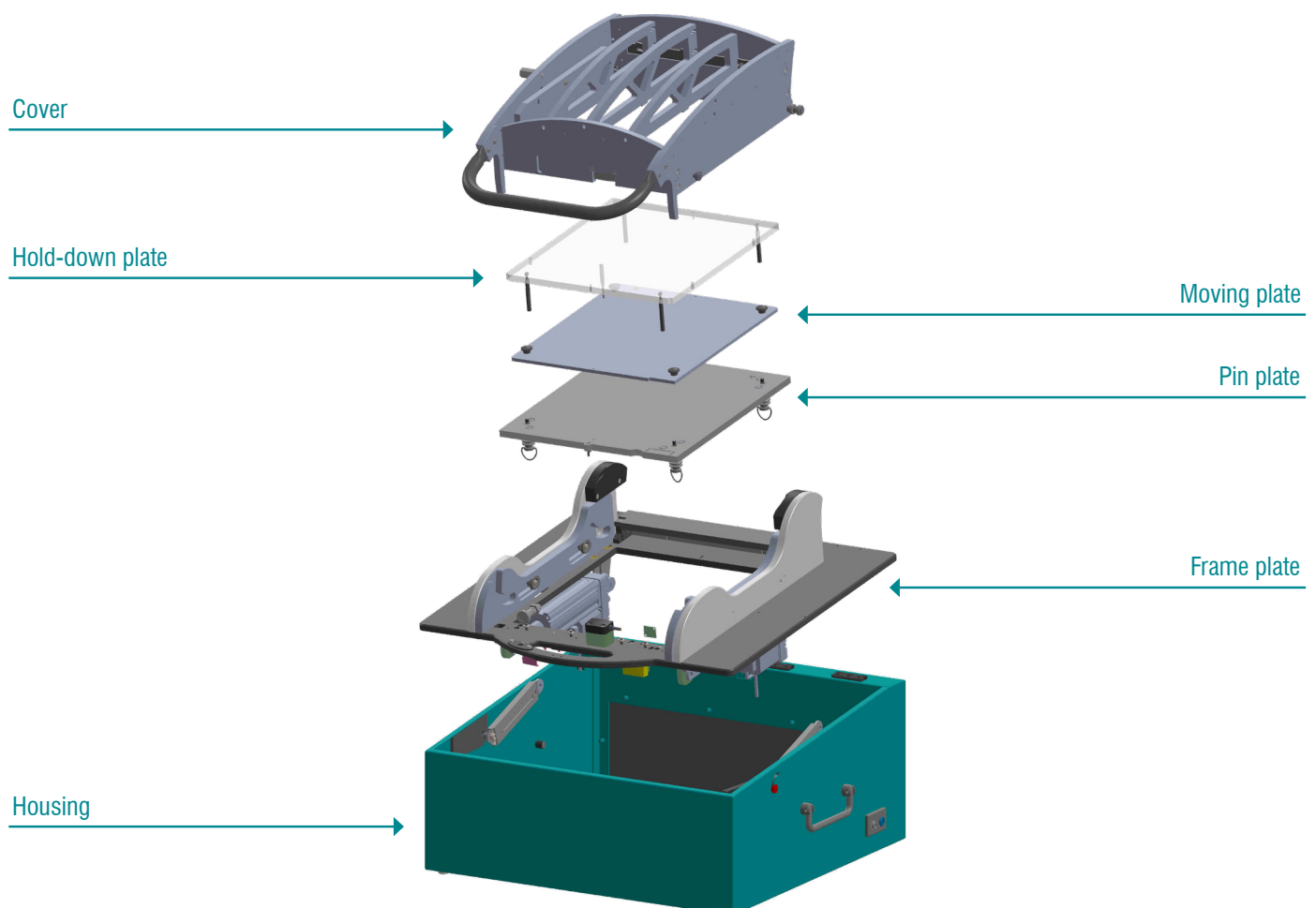

ELECTROMECHANICAL FIXTURE



HIGHLIGHTS

- Highest operating comfort
- High quantity
- Mature technology
- Bi-level capable
- Extremely expandable

MEE - ELECTROMECHANICAL FIXTURE

Maximum comfort with the highest output

The value of an fixture solution increases with the test cycles you reliably achieve with it day after day. That's why we have consistently designed our mechanical manual test stations to implement the highest quantities. Our extremely robust electromechanical fixture model MEE helps you to set all switches correctly. In their daily work, your operators benefit from fatigue-free operation with minimum effort. The freely programmable electromechanical drives of the MEE also make maximum flexibility possible.

Other highlights of the MEE include its optionally available, stepless bi-level capability, which qualifies it for maximum universal applicability. This allows the assembly under test to be approached at any desired height and in several stages. Like all fixtures of our successful ME series, you can also use the MEE for functional and smaller ICT tests up to approx. 1,000 N.

MOVING SECTION

MEE

The moving section of the cassette contains an integrated brass plate which short-circuits three probes (probes not fitted) – can be used as a starting signal.

STANDALONE FIXTURE LEGEND

Electromechanical fixture

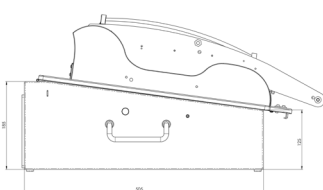

MEE-Standard height

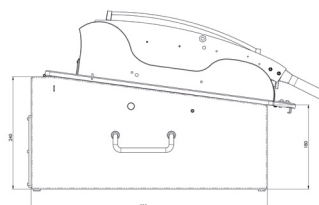

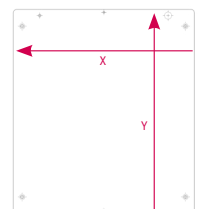

MEE-Special height



Moving plate dimension X x Y

ELECTROMECHANICAL FIXTURE

ELECTROMECHANICAL FIXTURE

Designation	Fixture	Moving plate (X x Y)	Standard housing	Order number
MEE-B*		275 x 310	E01-00124	100845
MEE-C		445 x 310	E01-00061	100846

All fixtures marked with * are also available with a high housing.

AVAILABLE HOUSING TYPES

FOR MEE TO FIT FLEXIBLY INTO YOUR TEST ENVIRONMENT

Housing with back panel (connectors can be mounted as required)

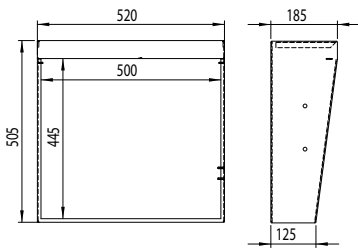

E01-00124

Standard housing for MEE-B

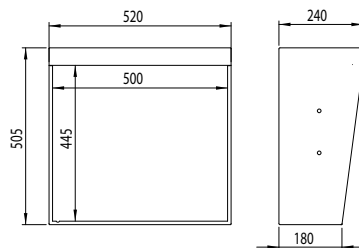

E01-00123

High housing for MEE-B

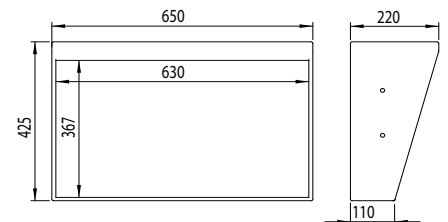

E01-00061

Standard housing for MEE-C

INTERFACE

POSSIBILITY OF MOUNTING AN INTERFACE ON THE REAR WALL

The GFK-Aperture is installed in our test fixtures as standard. All other interface mounting options can be ordered with or without the respective interface.

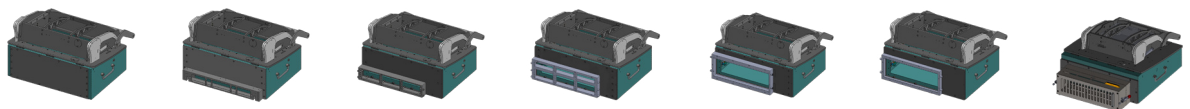

Interface Housing	GFK-Aperture	Pylon	VPC G12	VPC G12X	VPC G20	VPC G25	Reinhardt
E01-00061	x						
E01-00123	x	x	x				
E01-00124	x	x	x				x

Technical assignments shown above are standard designs. However, due to our high variety of housings, special designs can be made after consultation.

ELECTROMECHANICAL EXCHANGEABLE CASSETTE SYSTEM

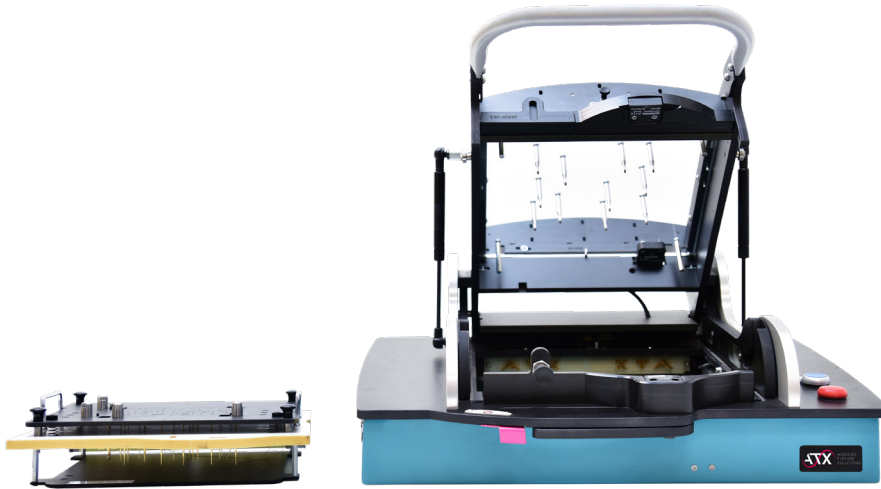

MEEW - ELECTROMECHANICAL EXCHANGEABLE CASSETTE SYSTEM

Offers you even more flexibility

Do you frequently change products to be tested at short intervals? Then you should opt for the MEEW model variant with changing system. This allows the necessary product changeovers to be mastered quickly and safely without tools, while the wear-resistant interface guarantees minimal maintenance and the shortest possible setup times.

A wide range of special pins such as HF, power or compressed air transfer is available for the individual interfaces. And to make your advantage perfect, this model with integrated changing system is also optionally infinitely bi-level capable.

MOVING SECTION

MEEW

The moving section of the cassette contains an integrated brass plate which short-circuits three probes (probes not fitted) – can be used as a starting signal.

EXCHANGEABLE SYSTEM LEGEND

Electromechanical exchangeable cassette system

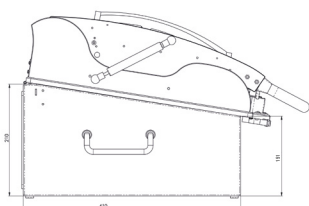

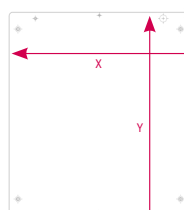

MEEW-Standard height



Moving plate dimension X x Y

ELECTROMECHANICAL EXCHANGEABLE CASSETTE SYSTEM

ELECTROMECHANICAL EXCHANGEABLE BASIC UNIT

Designation	Fixture	Moving plate (X x Y)	Standard housing	Order number
MEEWG-A		275 x 240	E01-00025	100847
MEEWG-B		445 x 240	E01-00061	100849

ELECTROMECHANICAL EXCHANGEABLE CASSETTE

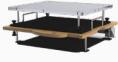
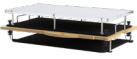
Designation	Cassette	Moving plate (X x Y)	Order Number
MEEWK-A		275 x 240	100848
MEEWK-B		445 x 240	100850

All fixtures marked with * are also available with a high housing.

AVAILABLE HOUSING TYPES

FOR MEEW TO FIT FLEXIBLY INTO YOUR TEST ENVIRONMENT

Housing with back panel (connectors can be mounted as required)

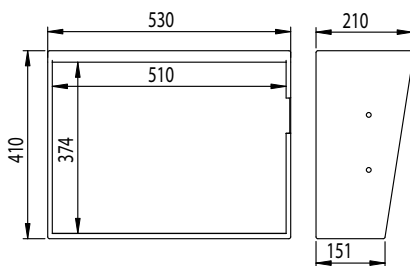

E01-00025

Standard housing for MEEWG-A

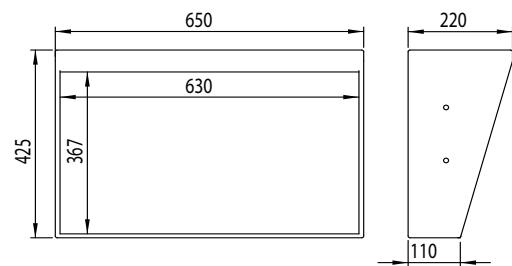

E01-00061

Standard housing for MEEWG-B

INTERFACE

POSSIBILITY OF MOUNTING AN INTERFACE ON THE REAR WALL

The GFK-Aperture is installed in our test fixtures as standard. All other interface mounting options can be ordered with or without the respective interface.

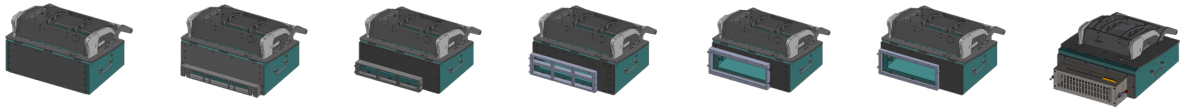

Interface Housing	GFK-Aperture	Pylon	VPC G12	VPC G12X	VPC G20	VPC G25	Reinhardt
E01-00025	x	x	x	x		x	
E01-00061	x						

The assignments shown above are standard designs. However, due to our high variety of housings, special designs can be made after consultation.

FIXTURE CONFIGURATOR

CONFIGURE YOUR INDIVIDUAL TEST FIXTURE

MEE-Series

Our fixture configurator was developed especially for you. Together with our sales specialists and designers, it is constantly adapted and further developed. Configure your individual test fixture now, which is specially adapted to your needs, on our homepage and receive your exclusive offer.

▶▶ **Go to configurator** (https://www.abx-hardware.de/en/product-category/mechanical_fixtures/mee-mechanical-electrical/)

SPARE PARTS FOR THE MEE-SERIES

IDEAL CONDITIONS FOR EFFICIENT OPERATION

Basic unit

MEWG-IF combined module interface

Order number	Designation
100837	MEWG-IF combined module interface Pneu-HF-HS basic unit

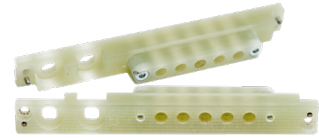

High-current contact with receptacle combined module interface

Order number	Designation
629001	High-current contact I Probe
689037	High-current contact I Receptacle



Interface contact basic unit

Order number	Designation
621001	Interface contact basic unit I Probe
621002	Interface contact basic unit I Receptacle



Pneumatic coupling

Order number	Designation
278256	Pneumatic coupling combined module interface - basic unit



High-frequency contact

Order number	Designation
300049	High-frequency contact combined module interface basic unit 50 Ohm RG178 with cable (90 cm)



SPARE PARTS FOR THE MEE-SERIES

IDEAL CONDITIONS FOR EFFICIENT OPERATION

Cassette version

MEWK-IF combined module interface

Order number	Designation
100838	MEWK-IF combined module interface Pneu-HF-HS cassette



High-current contact

Order number	Designation
670034	High-current contact combined module interface cassette up to 50 A



Interface contact exchangeable cassette system

Order number	Designation
670054	Interface contact exchangeable cassette (SIP with inner cone)



Pneumatic coupling

Order number	Designation
278255	Pneumatic coupling combined module interface cassette



High-frequency contact

Order number	Designation
300044	High-frequency contact combined module interface cassette 50 Ohm RG178 with cable (90 cm)



Spacer

Order number	Designation
439003	Spacer (3 mm height, thickness = 2.5 mm, drill hole 1.9-2.0)



Pushfinger length 45 mm

Order number	Designation
433107	Pushfinger length 45 mm Standard pushfinger ME series with UUT of 1.6 mm thickness and use of spacer supports 439003





ATX HARDWARE GMBH WEST

Location Pürgen | Am Wiesengrund | 86932 Pürgen

Location Weil im Schönbuch | Carl-Zeiss-Straße 5/1 | 71093 Weil im Schönbuch

P +49 8196 9304-0

F +49 8196 9304-19

projekte@atx-hardware.de

www.atx-hardware.de