



MEP-SERIES

MECHANICAL,
PNEUMATIC

CONTENTS

3	Specialist fixture solutions
3	Fixture assembly
4	Pneumatic fixture <i>MEP</i>
5	Available housing types
6	Interface
7	Pneumatic exchangeable cassette system <i>MEPW</i>
8	Available housing types
9	Interface
10	Pneumatic fixture <i>MEP100</i>
11	Available housing types
11	Interface
12	Pneumatic exchangeable cassette system <i>MEP100W</i>
13	Available housing types
13	Interface
14	Fixture configurator
14	Spare parts for the MEP-Series

Imprint

Publisher:

ATX Hardware GmbH West

Am Kornfeld 8

86932 Pürgen

Germany

Phone +49 8196 9304-0

Telefax + 49 8196 9304-19

E-Mail: projekte@atx-hardware.de

Website: www.atx-hardware.de

SPECIALIST FIXTURE SOLUTIONS

ATX is Europe's market leader in the manufacture of test fixtures for electronic test procedures.

Why you too should choose an ATX fixture - it's simple:

TECHNICAL KNOW-HOW

Our sales team is technically well versed - our consultants are selected from the design team or other technical departments.

PROJECT KNOW-HOW

We work together with you towards a common goal: to find and implement the optimal solution for your individual testing requirements.

KNOWLEDGE BASE

Our employees bring well over 1,000 man-years of fixture building experience to the team.

SINCE 1997

FIXTURE ASSEMBLY

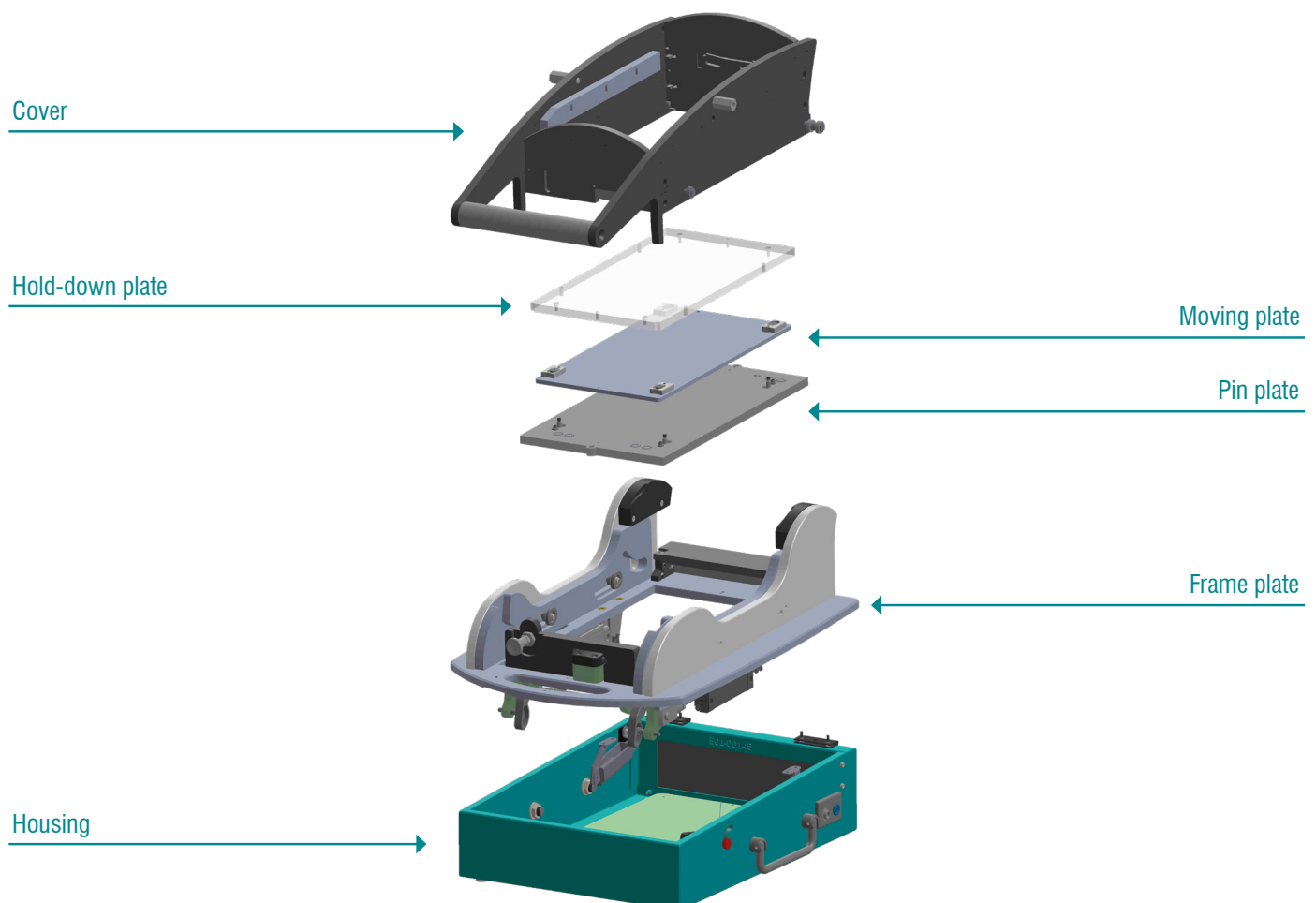

PNEUMATIC FIXTURE

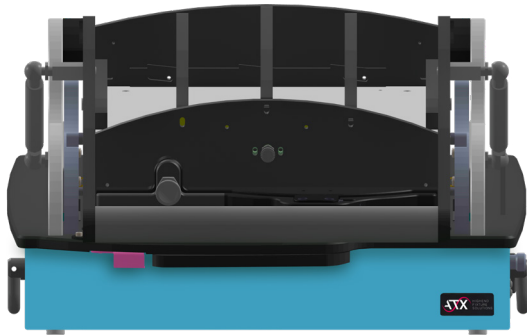

HIGHLIGHTS

- Individually expandable
- Versatile equipment
- Cost effective
- Easy to control
- Bi-level capable

MEP - PNEUMATIC FIXTURE

Maximum comfort with the highest output

ATX's MEP device model is perfect if you want to bring exceptional flexibility to your test and inspection area with the simplest control via the compressed air valve. As a standalone fixture, your MEP is perfect for functional testing, final testing and smaller ICT applications up to 1,000 N. With your MEP it is very easy to increase the number of cycles without spending more power. Thus, our MEP is exemplary for fatigue-free works. Its cover opens automatically and thus also ensures the fast ejection of defect-free parts.

Thanks to its compact design and space-saving mechanics, you can flexibly combine it with numerous additional components. A special product advantage that is only available with ATX: Our MEP is also optionally bi-level capable and furthermore available in the special version with pylon interface if required. It was tested at ATX with over 1 million strokes under full load for its superior endurance capability. It passed this test with flying colors, making it perfect for your high-volume production.

MOVING SECTION

MEP

The moving section of the cassette contains an integrated brass plate which short-circuits three probes (probes not fitted) – can be used as a starting signal.

STANDALONE FIXTURE LEGENDE

Pneumatic fixture

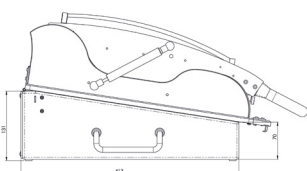

MEP-Standard height

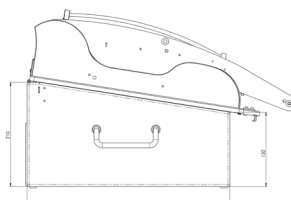

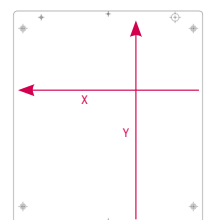

MEP-Special height



Moving plate dimension X x Y

PNEUMATIC FIXTURE

PNEUMATIC FIXTURE

Designation	Fixture	Moving plate (X x Y)	Standard housing	Order number
MEP-A		173 x 310	E01-00145	100233
MEP-B*		275 x 310	E01-00001	100811
MEP-C*		445 x 310	E01-00002	100812

All fixtures marked with * are also available with a ahigh housing.

AVAILABLE HOUSING TYPES

FOR MEP TO FIT FLEXIBLY INTO YOUR TEST ENVIRONMENT

Housing with back panel (connectors can be mounted as required)

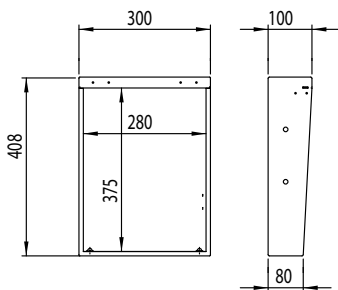

E01-00145

Standard housing for MEP-A

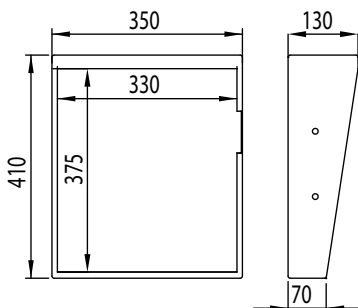

E01-00001

Standard housing for MEP-B

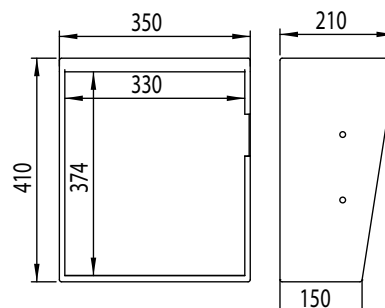

E01-00012

High housing for MEP-B

AVAILABLE HOUSING TYPES

FOR MEP TO FIT FLEXIBLY INTO YOUR TEST ENVIRONMENT

Housing with back panel (connectors can be mounted as required)

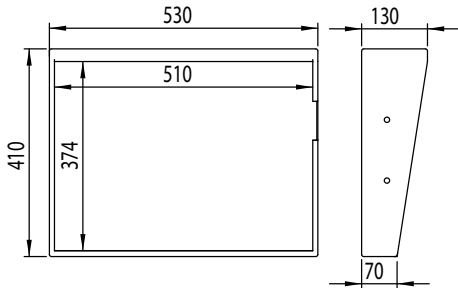

E01-00002

Standard housing for MEP-C

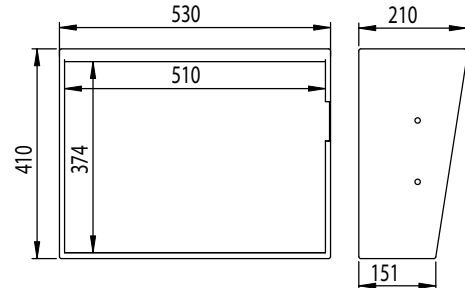

E01-00025

High housing for MEP-C

INTERFACE

POSSIBILITY OF MOUNTING AN INTERFACE ON THE REAR WALL

The GFK-Aperture is installed in our test fixtures as standard. All other interface mounting options can be ordered with or without the respective interface.

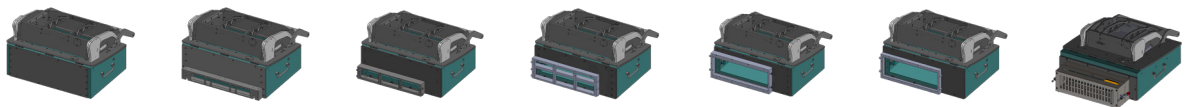

Interface Housing	GFK-Aperture	Pylon	VPC G12	VPC G12X	VPC G20	VPC G25	Reinhardt
E01-00001	x						
E01-00002	x	x					
E01-00012	x						
E01-00025	x	x	x	x		x	
E01-00145	x						

The assignments shown above are standard designs. However, due to our high variety of housings, special designs can be made after consultation.

PNEUMATIC EXCHANGEABLE CASSETTE SYSTEM



MEPW - PNEUMATIC EXCHANGEABLE CASSETTE SYSTEM

Maximum dynamics with integrated exchangeable cassette system

As an attractive alternative, we can also offer you this model as a MEPW product variant with pneumatic exchangeable cassette system. The cost-effective cassette solution is suitable for many changing products and saves you a lot of time during product changeover thanks to tool-free changeover.

Further advantages are minimal maintenance and shorter set-up times due to the wear-resistant interface. Individual interfaces for special pins such as HF, power or compressed air transfers are available.

MOVING SECTION

MEPW

The moving section of the cassette contains an integrated brass plate which short-circuits three probes (probes not fitted) – can be used as a starting signal.

EXCHANGEABLE SYSTEM LEGEND

Pneumatic exchangeable cassette system

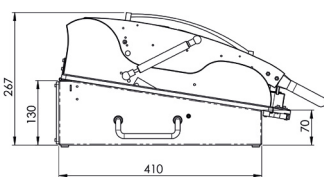

MEPW-Standard height

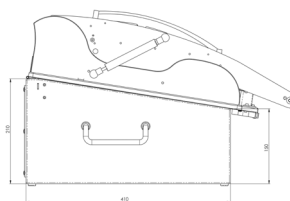

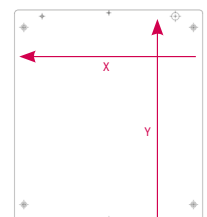

MEPW-Special height





Moving plate dimension X x Y

PNEUMATIC EXCHANGEABLE CASSETTE SYSTEM

PNEUMATIC EXCHANGEABLE BASIC UNIT

Designation	Fixture	Moving plate (X x Y)	Standard housing	Order number
MEPWG-A*		275 x 240	E01-00115	100813
MEPWG-B*		445 x 240	E01-00117	100825
PWG-Pylon-1		444 x 276	E01-00109	100978

PNEUMATIC EXCHANGEABLE CASSETTE

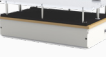
Designation	Cassette	Moving plate (X x Y)	Order number
MEPWK-A		275 x 240	100857
MEPWK-B		445 x 240	100826
PWK-Pylon-1		444 x 276	100980

All fixtures marked with * are also available with a high housing.

AVAILABLE HOUSING TYPES

FOR MEPW TO FIT FLEXIBLY INTO YOUR TEST ENVIRONMENT

Housing with back panel (connectors can be mounted as required)

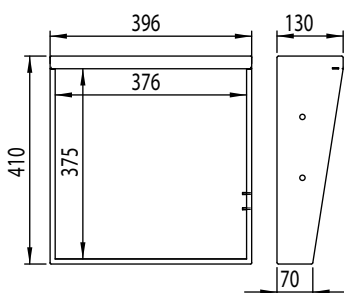

E01-00115

Standard housing for MEPWG-A

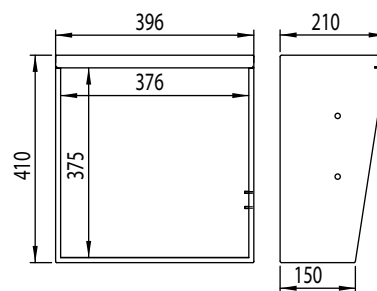

E01-00116

High housing for MEPWG-A

AVAILABLE HOUSING TPYES

FOR MEPW TO FIT FLEXIBLY INTO YOU TEST ENVIRONMENT

Housing with back panel (connectors can be mounted as required)

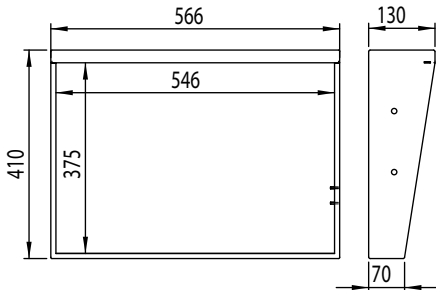

E01-00117

Standard housing for MEPWG-B

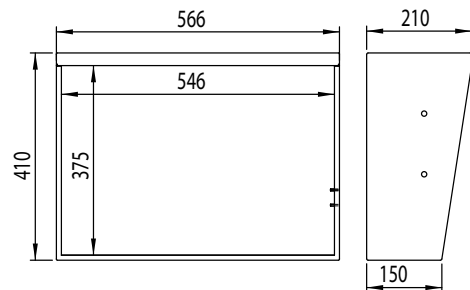

E01-00118

High housing for MEPWG-B

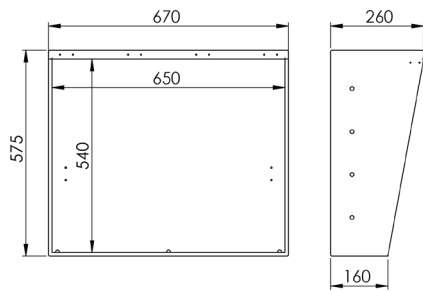

E01-00109

Standard housing for PWG-Pylon-1

INTERFACE

POSSIBILITY OF MOUNTING AN INTERFACE ON THE REAR WALL

The GFK-Aperture is installed in our test fixtures as standard. All other interface mounting options can be ordered with or without the respective interface.

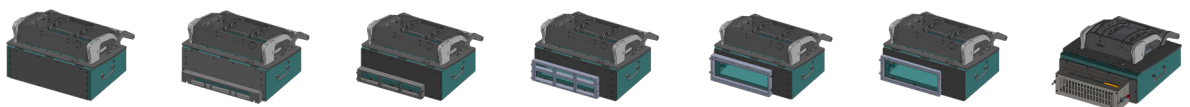

Housing \ Interface	GFK-Aperture	Pylon	VPC G12	VPC G12X	VPC G20	VPC G25	Reinhardt
E01-00109	X	X					
E01-00115	X						
E01-00116	X						
E01-00117	X	X	X				
E01-00118	X	X	X	X	X	X	

The assignments shown above are standard designs. However, due to our high variety of housings, special designs can be made after consultation.

PNEUMATIC FIXTURE



HIGHLIGHTS

- Large opening angle
- Auto-open-close function
- Safety concept
- Exchangeable system variant

MEP100 - PNEUMATIC FIXTURE

Automatic testing

The MEP100 is your fixture when it comes to flexibility and automation. Thanks to the different mode variants such as „independent opening and closing“, „opening only, manual closing“ or „completely manually operated“, you can integrate the fixture completely freely into your production processes and flexibly allocate your capacities. It does not matter whether you operate it with your personnel or with a robot. A sophisticated safety concept has been developed to ensure safe operation. A combination of patented safety mechanics and monitoring by a safety PLC prevents any dangers for your employees.

For easy use, the control system has already been pre-programmed and the MEP100 can be conveniently connected to any desired test system via potential-free inputs. Another advantage: The connection of all possible interfaces as well as different housing variants are easily configurable.

Robust and precise

An enlarged opening angle gives both your employees and the robot used plenty of space for loading and unloading the assemblies. We also continue to rely on the proven MEP mechanics, which has already proven its reliability in millions of assemblies. The MEP100 is therefore highly valued, especially in high-volume production, and is regarded as robust and precise.

STANDALONE FIXTURE LEGEND

Pneumatic fixture

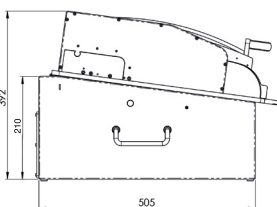

MEP100-Standard height

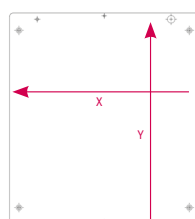

Moving plate dimension X x Y

PNEUMATIC FIXTURE

PNEUMATIC FIXTURE

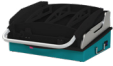
Designation	Fixture	Moving plate (X x Y)	Standard housing	Order number
MEP100-B		275 x 310	E01-00123	100246
MEP100-C		445 x 310	E01-00133	100239

AVAILABLE HOUSING TYPES

FOR MEP100 TO FIT FLEXIBLY INTO YOUR TEST ENVIRONMENT

Housing with back panel (connectors can be mounted as required)

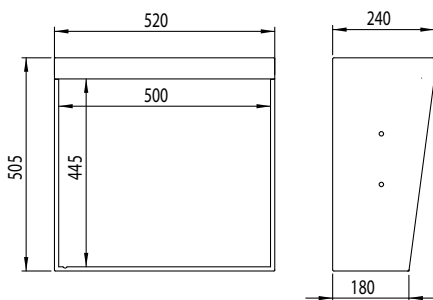

E01-00123

Standard housing for MEP100-B

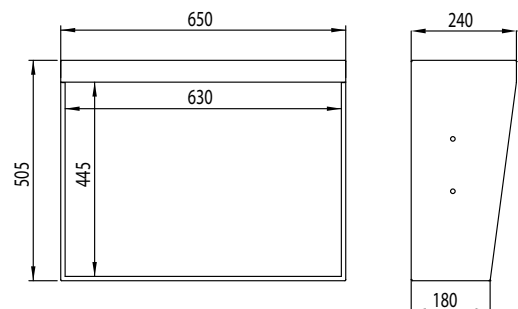

E01-00133

Standard housing for MEP100-C

INTERFACE

POSSIBILITY OF MOUNTING AN INTERFACE ON THE REAR WALL

The GFK-Aperture is installed in our test fixtures as standard. All other interface mounting options can be ordered with or without the respective interface.

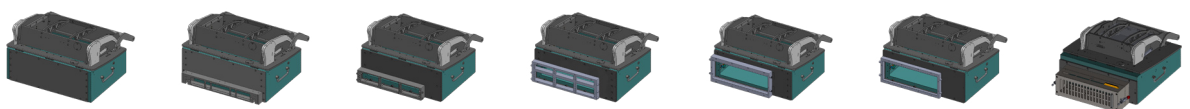

Interface Housing	GFK-Aperture	Pylon	VPC G12	VPC G12X	VPC G20	VPC G25	Reinhardt
E01-00123	X	X	X				
E01-00133	X	X	X			X	

The assignments shown above are standard designs. However, due to our high variety of housings, special designs can be made after consultation.

PNEUMATIC EXCHANGEABLE CASSETTE SYSTEM

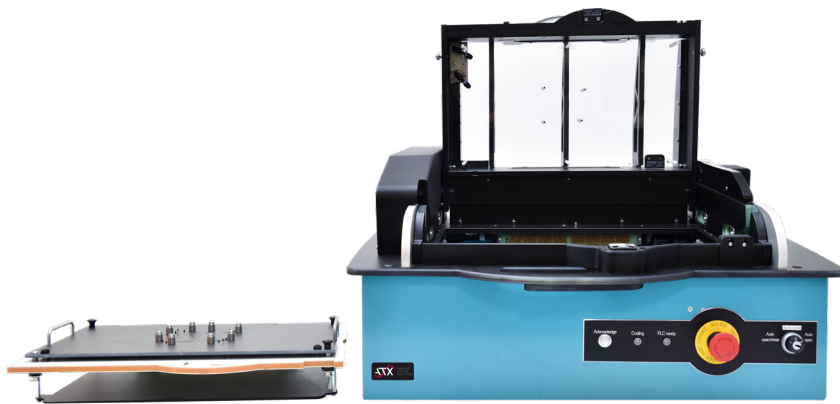

HIGHLIGHTS

- Exchangeable cassette system
- Auto-open-close function
- Safety concept
- Bi-level compatible

MEP100W - PNEUMATIC EXCHANGEABLE CASSETTE SYSTEM

Economical and automatic testing

The MEP100W combines the advantages of the MEP100 with an economical exchangeable cassette system. By exchanging a simple exchangeable cassette, product changeover can be carried out easily and inexpensively. The basic unit with the control system and the auto open - auto close mechanism only needs to be purchased once and can remain on the test system.

Optionally, the cassette can be interrogated with a coding. An interlock system is then used to exclude an incorrect combination of upper and lower part, thus preventing damage to an assembly or an exchangeable cassette. This interlock system can also be used as a positive locking device for safety-related voltages or other dangers. The coding interface in the hold-down plate can be combined with a pneumatic transfer. This means that pneumatics are also available on the top side. The interface is designed for 480 pins and can be extended with special pins such as HF or high-current pins. As an option, expansion as a bi-level device (2 stages for separation of FKT and ICT) is also available.

EXCHANGEABLE SYSTEM LEGEND

Pneumatic exchangeable cassette system

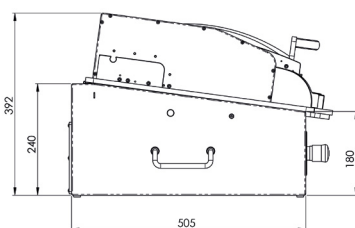

MEP100W-Standard height

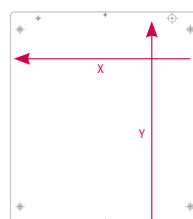

Moving plate dimension X x Y

PNEUMATIC EXCHANGEABLE CASSETTE SYSTEM

PNEUMATIC EXCHANGEABLE BASIC UNIT

Designation	Fixture	Moving plate (X x Y)	Standard housing	Order number
MEP100WG-B		445 x 240	E01-00133	100266

PNEUMATIC EXCHANGEABLE CASSETTE

Designation	Cassette	Moving plate (X x Y)	Order number
MEP100WK-B		445 x 240	100270

AVAILABLE HOUSING TYPES

FOR MEP100W TO FIT FLEXIBLY INTO YOUR TEST ENVIRONMENT

Housing with back panel (connectors can be mounted as required)

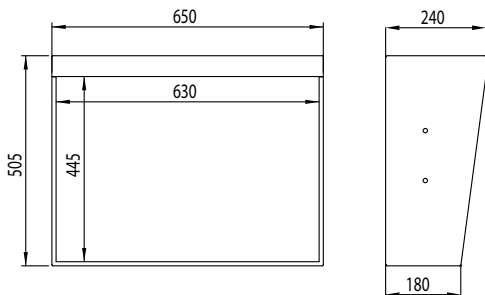

E01-00133

Standard housing for MEP100WG-B

INTERFACE

POSSIBILITY OF MOUNTING AN INTERFACE ON THE REAR WALL

The GFK-Aperture is installed in our test fixtures as standard. All other interface mounting options can be ordered with or without the respective interface.

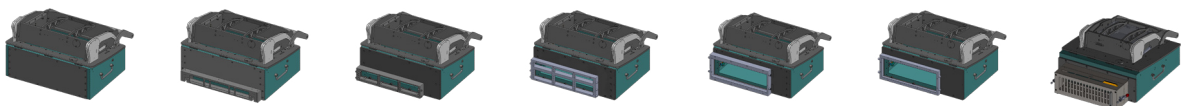

Interface Housing	GFK-Aperture	Pylon	VPC G12	VPC G12X	VPC G20	VPC G25	Reinhardt
E01-00133	X	X	X			X	

The assignments shown above are standard designs. However, due to our high variety of housings, special designs can be made after consultation.

FIXTURE CONFIGURATOR

CONFIGURE YOUR INDIVIDUAL TEST FIXTURE

MEP-Series

Our fixture configurator was developed especially for you. Together with our sales specialists and designers, it is constantly adapted and further developed. Configure your individual test fixture now, which is specially adapted to your needs, on our homepage and receive your exclusive offer.

» **Go to configurator** (https://www.atx-hardware.de/en/product-category/mechanical_fixtures/mep-mechanical-pneumatic/)

SPARE PARTS FOR THE MEP-SERIES

IDEAL CONDITIONS FOR EFFICIENT OPERATION

Basic unit

High-current contact with receptacle combined module interface

Order number	Designation
629001	High-current contact I Probe
689037	High-current contact I Receptacle



Interface contact basic unit

Order number	Designation
621001	Interface contact basic unit I Probe
621002	Interface contact basic unit I Receptacle



Pneumatic coupling

Order number	Designation
278256	Pneumatic coupling combined module interface - basic unit



High-frequency contact

Order number	Designation
300049	High-frequency contact combined module interface basic unit 50 Ohm RG178 with cable (90 cm)



SPARE PARTS FOR THE MEP-SERIES

IDEAL CONDITIONS FOR EFFICIENT OPERATION

Cassette version

High-current contact

Order number	Designation
670034	High-current contact combined module interface cassette up to 50 A



Interface contact exchangeable cassette system

Order number	Designation
670054	Interface contact exchangeable cassette (SIP with inner cone)



Pneumatic coupling

Order number	Designation
278255	Pneumatic coupling combined module interface cassette



High-frequency contact

Order number	Designation
300044	High-frequency contact combined module interface cassette 50 OHM RG178 with cable (90 cm)



Spacer

Order number	Designation
439003	Spacer (3 mm height, thickness = 2.5 mm, drill hole 1.9-2.0)



Pushfinger length 45 mm

Order number	Designation
433107	Pushfinger length 45 mm Standard pushfinger ME series with UUT of 1.6 mm thickness and use of spacer supports 439003





ATX HARDWARE GMBH WEST

Location Pürgen | Am Wiesengrund 12 | 86932 Pürgen
Location Weil im Schönbuch | Carl-Zeiss-Straße 5/1 | 71093 Weil im Schönbuch

P +49 8196 9304-0
F +49 8196 9304-19
projekte@atx-hardware.de

www.atx-hardware.de